

**G U I  
D E D  
S U  
R G E  
R Y**



**B&B DENTAL**  
IMPLANT COMPANY



# WORKFLOW



1

DIAGNOSIS



2

PRECISE IMPRESSION  
REGISTRATION



8

SURGERY

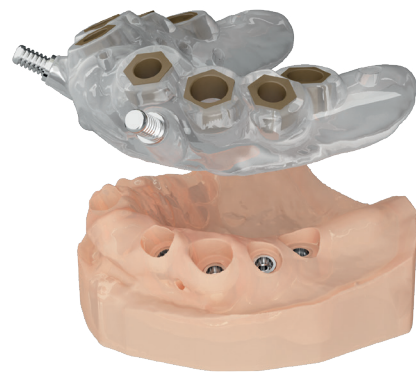

7

SURGICAL TEMPLATE CREATION



3

**RADIOGRAPHIC TEMPLATE**



4

**CBCT SCAN IMAGING**

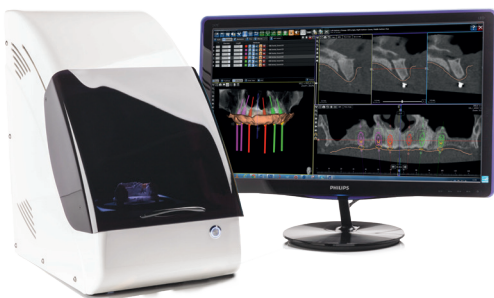

6

**SCANNING AND PLANNING**

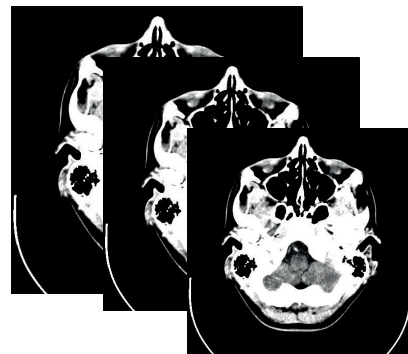

5

**DICOM AND STL DIGITAL FILES  
TRANSMISSION OR CAST MODEL  
AND TEMPLATE DELIVERY**

# CONEXA CONNECTION

## PROSTHETIC SCREW

It sets abutment and implant with full conometry. There is no failure risk because it is not loaded.

## PLATFORM SWITCHING

Reduction of bone loss  
Long-term aesthetic stability  
Hinders bacteria infiltration  
Improved emerging aesthetic profile  
Force distribution

## TAPER CONNECTION "MORSE-TYPE TAPER AT 5° TOTAL

Cold soldering  
Eliminates micro-movements  
Eliminates through bolt loosening

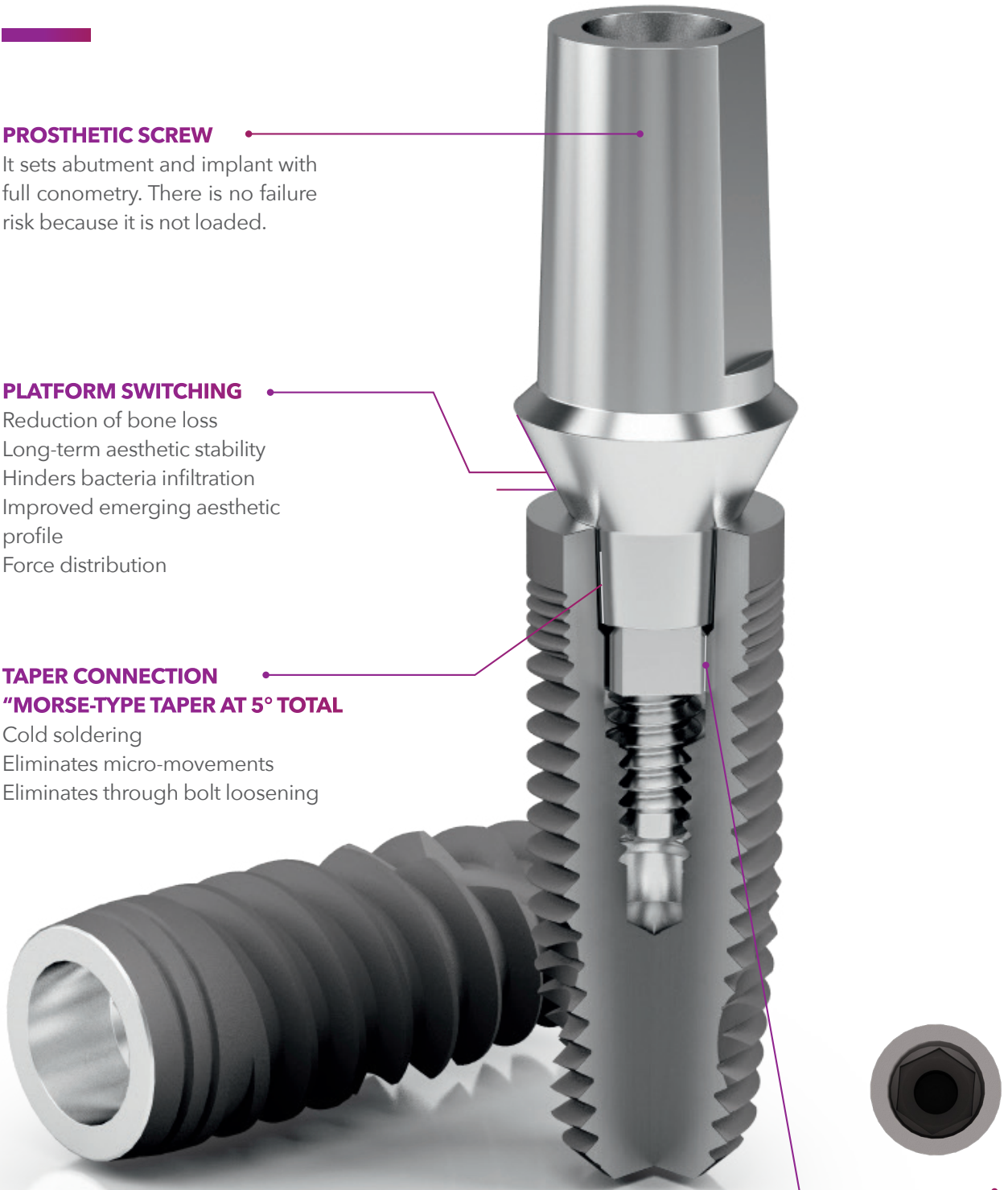

The various lines of the B&B Dental implant family (SLIM, 3P, EV and WIDE) allow you to use the most suitable implant design and size for each surgical site.  
The implants are available in diameters of 3.0 - 3.4 - 3.5 - 4.0 - 4.5 - 5.0.  
The uniform implant connection for upper-diameter implants at 3.40 offers different surgical options separated by morphology (3P - narrow thread - EV - large thread) but with a uniform prosthetic platform facilitating the processing and selection of prosthetic abutments.

## ESAGONO INTERNO

It ensures anti-rotation feature for absolute abutment positioning

# HOW TO USE THE SURGICAL KIT

It is useful to know the surgical accessories that make up the kit before proceeding with the description of the operative protocol. The morphology of the instruments inside the B&B DENTAL SURGICAL KIT is specifically designed for the guided insertion of the SLIM, 3P and EV line implants. The neck of the drills allow for a precise insertion inside the guided sleeve determining the depth of the osteotomy with a known full-travel stop at a distance of 9 mm from the crestal edge of the bone.

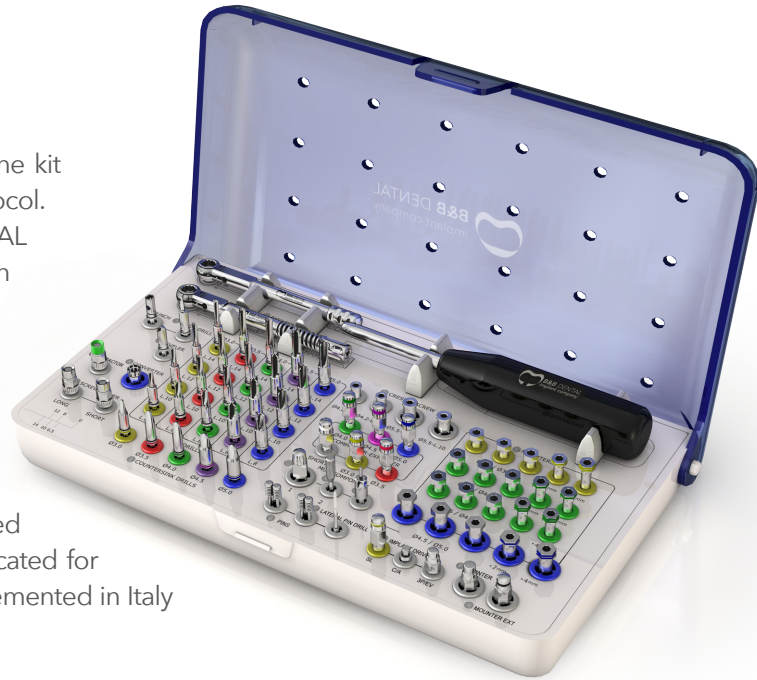

The materials used for the production of devices manufactured by B&B Dental were selected based on the properties indicated for their intended use, in compliance with Directive 93/42 implemented in Italy by Law 46/97, the attached essential requirements, point 7.1.

The surgical kit and the instruments contained in it are sold in non-sterile packs; the codes, description and lot number are listed on each package. It is essential that they are cleaned, disinfected and sterilized before use, according to the instructions on the enclosed leaflet.

The wearing down of the drills depends largely on the type of drilled bone density: harder bones carry greater wear on the instruments. It is recommended to check the maintenance status of the residual cutting capacity after each operation with particular focus on the initial tools of the protocol.

## IMPLANT LINES FOR GUIDED KIT

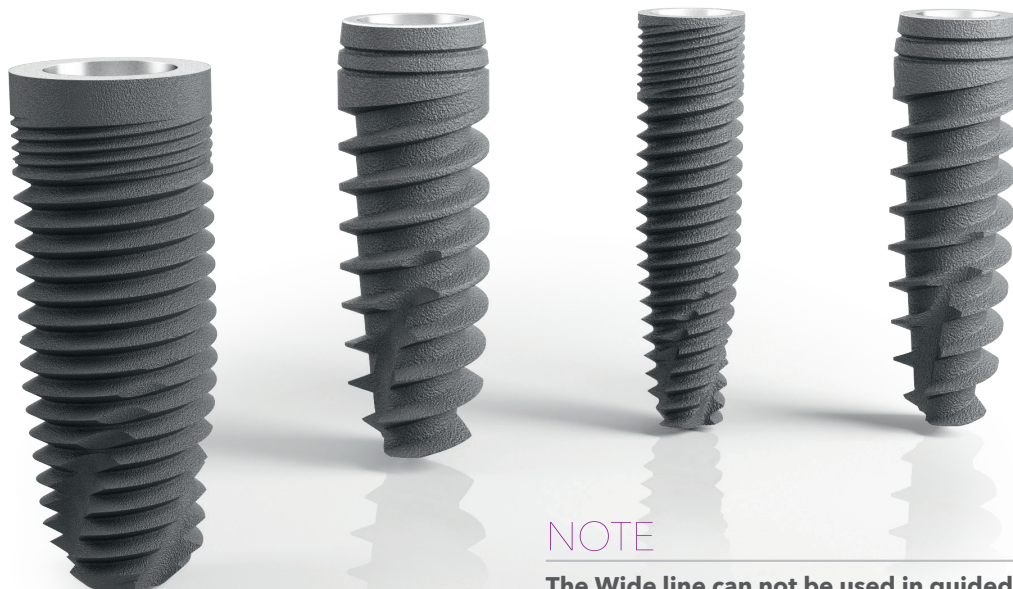

**NOTE**

The Wide line can not be used in guided surgery.

# WHEN IS IT POSSIBLE

## OPENING OF THE MOUTH

Guided surgery is a highly versatile technique that has made great strides in recent years. But we must remember that there are limits to the application of this technique to be evaluated before beginning this process. An important point is the patient's ability to keep their mouth open and the assessment of the overall dimensions of the drills and masks to be used. If the necessary conditions are not met, the evaluation of other approaches may be effective for the treatment of the patient.



## INTERDENTAL SPACE

The space between teeth should be measured with an instrument in order to allow for the precise positioning of the guided sleeve according to the diameter of the pre-selected implant suitable to the surgical site.

### 4.2 MM Ø SLEEVE

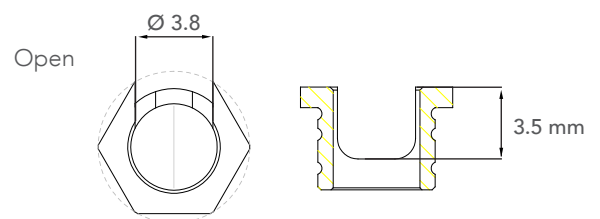
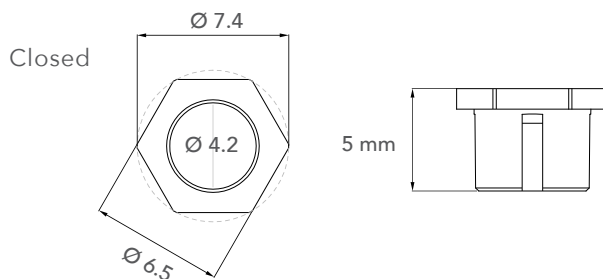

### 5.5 MM Ø SLEEVE

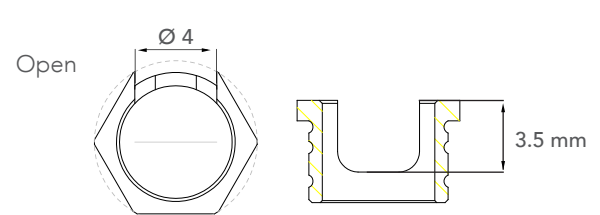
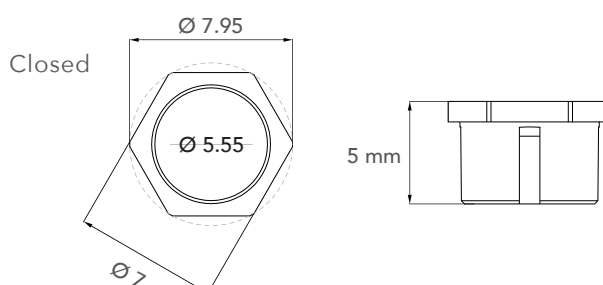

# FILES MATCHING

In order to create the surgical template, the digital acquisition of the STL file of the model or of the mouth and the DICOM file deriving from the cone beam is necessary. In order to match the data coming from the two files and evaluate the mucosal thicknesses (STL) and the dimensions and shape of the bone (DICOM) during surgical template planning, it is necessary to use radiopaque markers. These markers are small spheres recognized by the software that allow for the perfect placement of the two files on each other. Markers should be placed on the aesthetic trial of the prosthetic project with a homogeneous distribution with respect to the project itself.

## MATCHING WITH RESIDUAL TEETH

In the case of a project that involves a patient with residual teeth, the image matching can be done both with the correctly positioned markers or with the matching of the residual teeth themselves. It is important to pay particular attention to the presence of metal reconstructions that can generate scattering. In such case, it will be necessary to position the markers as described below.

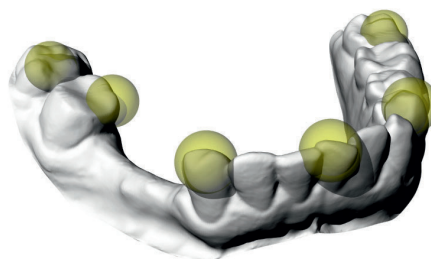

## MATCHING WITH RADIOPAQUE MARKERS

In the eventuality of a patient with a total edentulism, in order to allow for the matching of the files derived from the cone beam and of the extraoral and / or intraoral impressions, it is important to place the radiopaque markers forming triangles as shown in the image. In order to guarantee a high degree of precision, the reduced dimensions of the B&B Dental markers allow for easy image acquisition in the cone beam, thereby avoiding problems of falsification or incomplete acquisition (especially with large markers) in the case of a cone beam with an insufficient field of view (FOV) during the acquisition of the image.

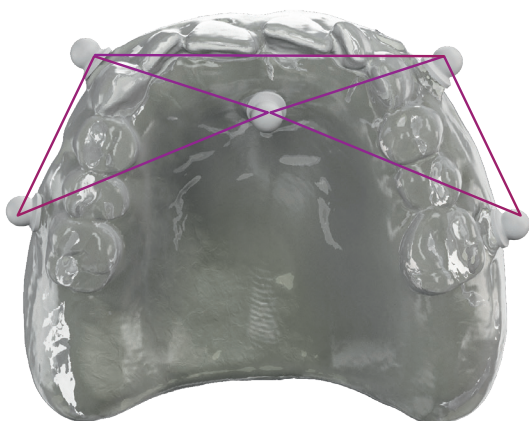

### QUANTITY

1 cf x 5 pz

### CODE

GD-SFERE

# SURGICAL TEMPLATE TYPES

---

A surgical template is a customized medical device that guides the drills and implants in the most suitable area, making the most of the available bone according to the patient's anatomical conformation and predisposition.

---

## DENTAL SUPPORT TEMPLATES

If the patient has a residual dentition, the template can use it as a support to achieve stability. If you require greater stability, you should use crestal pins. The crestal pins should be inserted after using a lance drill (3) and be chosen with a diameter that is consistent with the sleeve and the length depending on the implant to be inserted.





**MUCOSAL SUPPORTED TEMPLATE**

When there are no teeth present, the template will have an exclusively mucous support. In this situation, it will be necessary to use lateral pins and / or crestal pins. The lateral pins should be inserted after drilling the bone with the pin drill (C) inside the holes with dedicated sleeves, positioned in the vestibular area. The template in this phase must be held in place with a silicone bite.

However, lateral pins may not be enough sometimes; in this case you can use crestal pins, which are screws that are fixed in the implant sleeves after creating a hole with the lance drill (3) and be chosen with a diameter that is consistent with the sleeve and the length depending on the implant to be inserted.

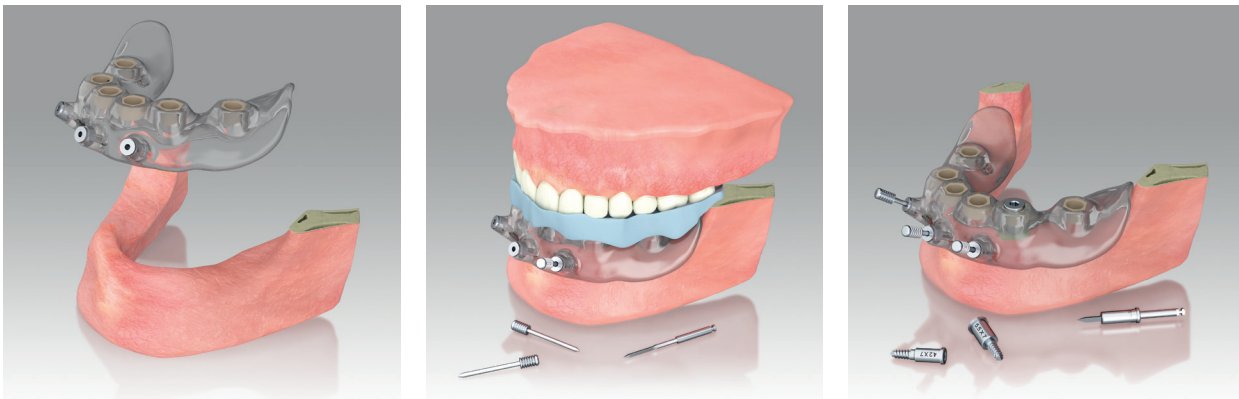

**BONE SUPPORTED TEMPLATE**

The bone-supported templates rest directly on the bone once the soft tissues have come off, and are adopted in cases where the bone appears to be irregular in shape and therefore an osteoplasty is required. This type of template should be fixed with lateral pins, after drilling the bone with the suitable drill (C). Also in this case, the use of crestal pins can increase stability if necessary.

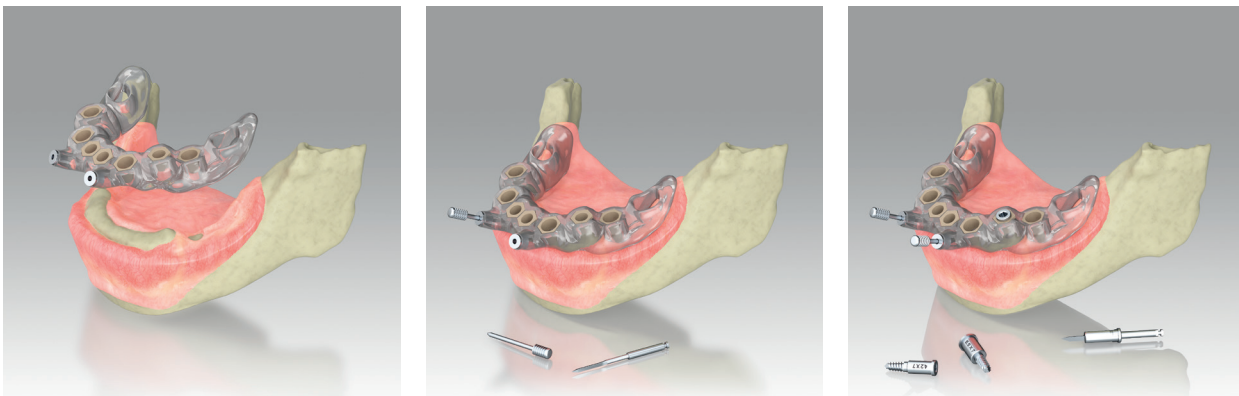

# GUIDED SLEEVES

The guided sleeves, also called sleeves, can have two dimensions and are presented as cylinders included in the surgical templates. They have the main function of guiding the surgical instruments during the preparation of the implant site by guiding the position and inclination of the drills. The sleeves are generally supplied incorporated into the surgical templates and, if necessary, can be supplied separately.

The sleeves have an external hexagon that allows you to correctly position the internal implant hexagon for prosthetic purposes, allowing for the correct position of the inclined abutments in regards to the prosthetic project. They are 5.0 mm high with a 4.2 mm (small sleeve) or 5.5 mm (large sleeve) internal diameter hole and provide a precise full-travel stop at 9 mm from the crestal edge of the bone on all instruments.

## LATERAL OPENING

It provides an easy access to the operative site

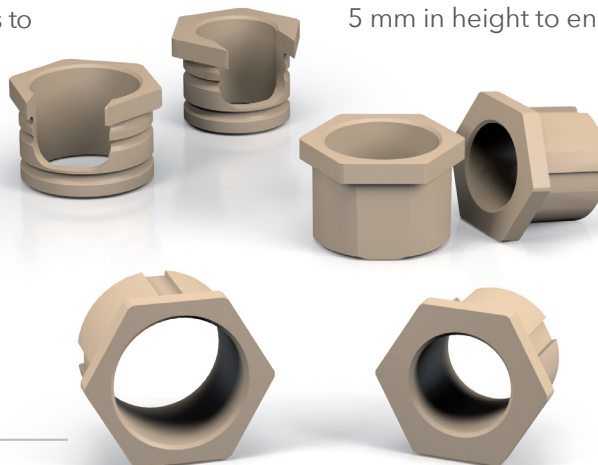

## ONE HEIGHT

5 mm in height to ensure a stable and safe guide.

## TWO DIAMETERS

A guaranteed guide for any implant diameter

















## HEXAGON

It provides an exact indication of the position of the hexagon implant.

## SLEEVES WITH LATERAL OPENING

Sleeves with a lateral opening are available for use in the posterior sets where there is difficulty in inserting the drills from above. The lateral opening allows for an easier access in areas where the length of the drills would be a hindrance. Thanks to the lateral opening, which is also described in the guide, it is possible to pass the drills laterally.

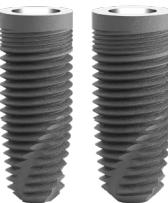

Ø SLEEVES	SLEEVES	MOUNTERS			IMPLANT	
Ø 4.2	 GD-764P 1 cf x 10 pz	 GD-768/3	+2  GD-768/32	+4  GD-768/34	 SLIM 3.0/3.4	
	 GD-703P 1 cf x 10 pz	 GD-768/1	+2  GD-768/12	+4  GD-768/14	 3P 3.5/4.0	 EV 4.0
Ø 5.5	 GD-765P 1 cf x 10 pz	 GD-768/2	+2  GD-768/22	+4  GD-768/24	 3P 4.5/5.0	 EV 4.5/5.0
	 GD-704P 1 cf x 10 pz		<td> </td> <td> </td> <td> </td> <td> </td>			

**SLEEVES MATERIAL**

B&B Dental pays particular attention to materials; the sleeves supplied are in peek, a material that is finding more and more applications in the dental sector. In this particular case, peek has greater precision as it is single-use, avoiding the friction and overheating of metal sleeves. Greater precision between sleeve and drill leads to less tilting of the drill itself.

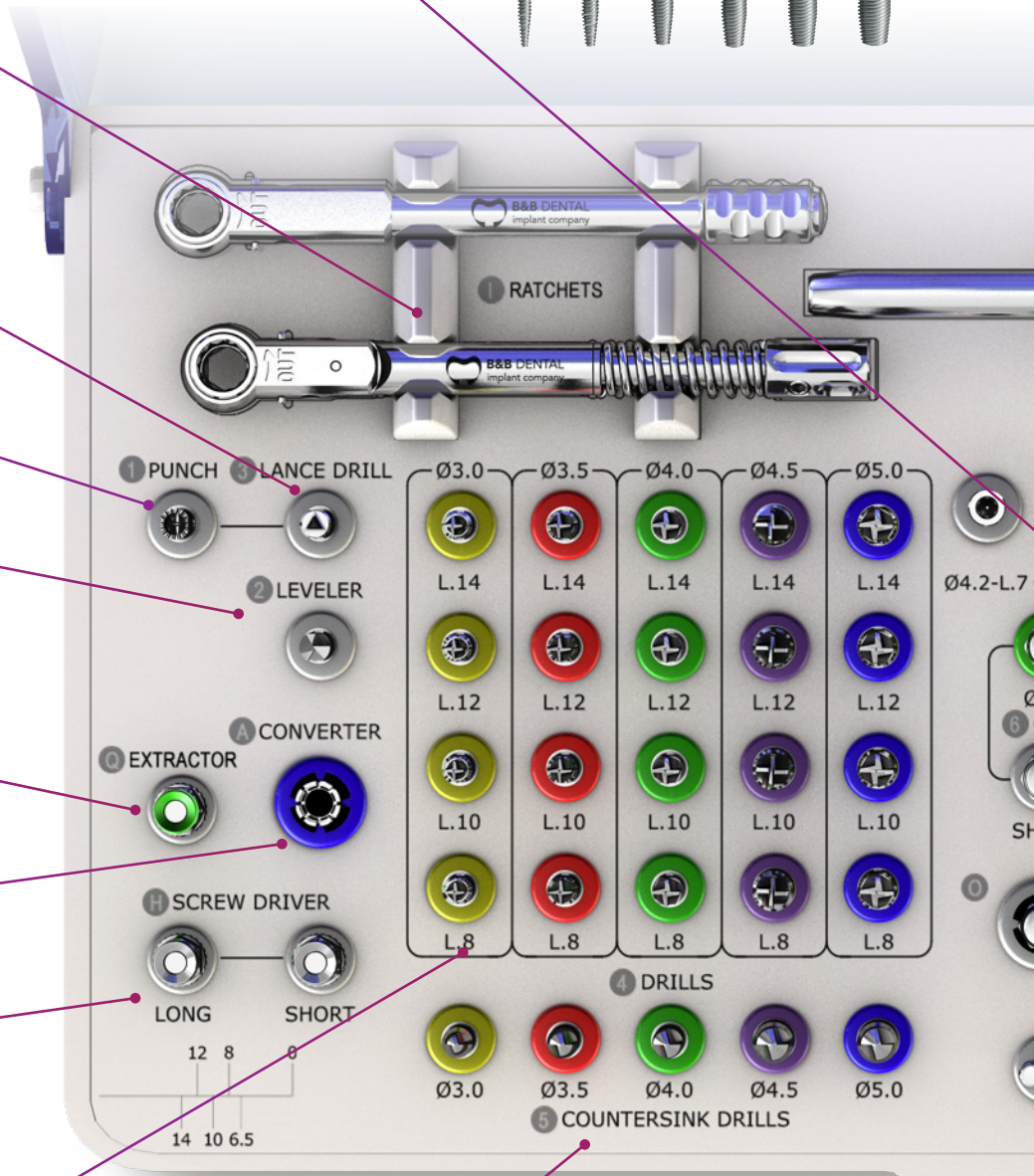
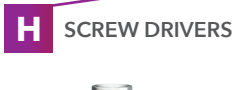
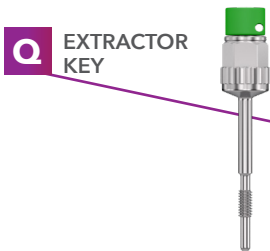
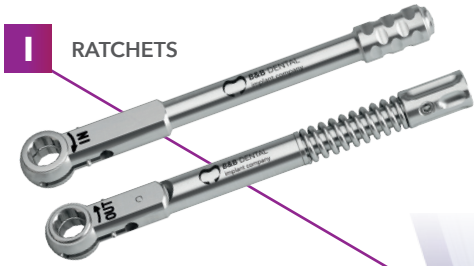

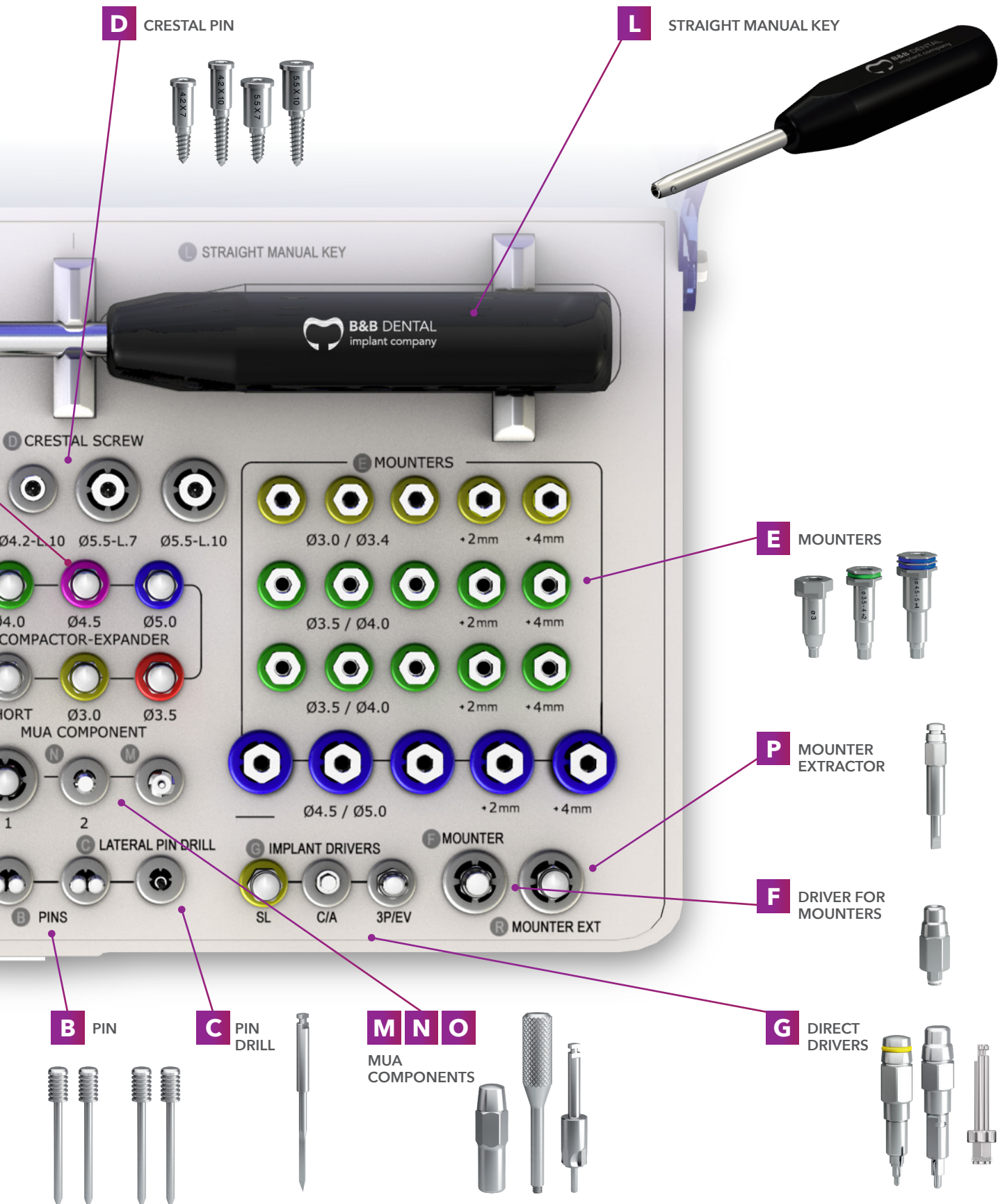

## B LATERAL PINS AND D CRESTAL PINS

Before positioning the surgery, you must make sure that the mask is stable. With dental support templates, you may find it unnecessary to fix the mask in place. However, in order to anchor the drilling template in its correct position and avoid micromovements during surgery, all other cases where fixing the mask is necessary require two options to achieve stability:

- in cases of total or partial edentulism, 2-3 lateral fixing pins (B) can be used and it may be necessary to use the drill pin (C) for insertion;
- in cases of total edentulism, the crestal fixing pins (D) are also available after using the lance drill (3); in order to screw them we use the driver for mounters)(F)

### METAL SLEEVE

For a confident guide and easy insertion of the lateral pins

### CRESTAL FIXING PIN

Forniscono una maggiore stabilità sfruttando l'osso crestale.

### PIN DRILL

It facilitates the insertion of the lateral fixing pins

### LATERAL FIXING PIN

They have the function of stabilizing the guide masks of a vestibular area

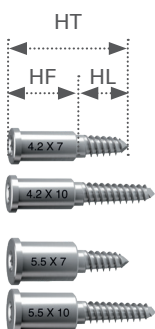
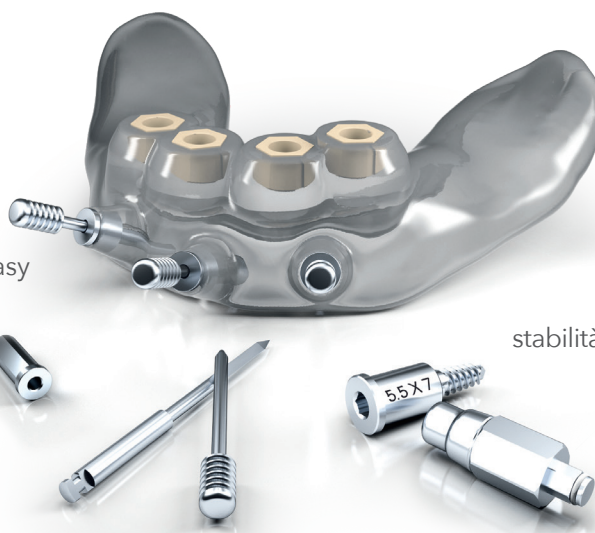

Ø	H	CODE
1.55mm ext 3.4mm	10	GD-BOG 1 cf x 4 pz
1.5	10	GD-FOG
1.5	20	GD-PING 1 cf x 4 pz

Ø PIN	HF Fix height	HL Labour height	HT Total height	CODE
Ø 4.2	9	7	17	GD-PIN/57
		10	19	GD-PIN/510
Ø 5.5	9	7	17	GD-PIN/67
		10	19	GD-PIN/610

# INITIAL SURGICAL INSTRUMENTS

## 1 MUCOTOMES

There is a mucotome inside the kit that can be used alone with 4.2 mm diameter sleeves or combined with a converter (A) that allows it to be adapted to the larger diameter sleeve.

### ONE FOR ALL DIAMETERS

Thanks to the converter it can also be used in 5.5 mm diameter sleeves.



### LATERAL HOLE

It allows for the drainage of liquids.

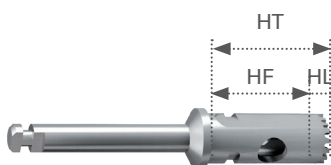

HF Fix height	HL Labour height	HT Total height	CODE
9	1	10	GD-263

RECOMMENDED SPEED: 100 rpm

# INITIAL SURGICAL INSTRUMENTS

## 2 CRESTAL LEVELLER

This drill is intended to level the work bone structure in order to provide better control of subsequent drills. The crestal leveller can be used separately with 4.2 mm diameter sleeves, but also in conjunction with the converter (A) for implant sites with 5.50 mm diameter sleeves.

### ONE FOR ALL DIAMETERS

Thanks to the converter it can also be used in 5.5 mm diameter sleeves.

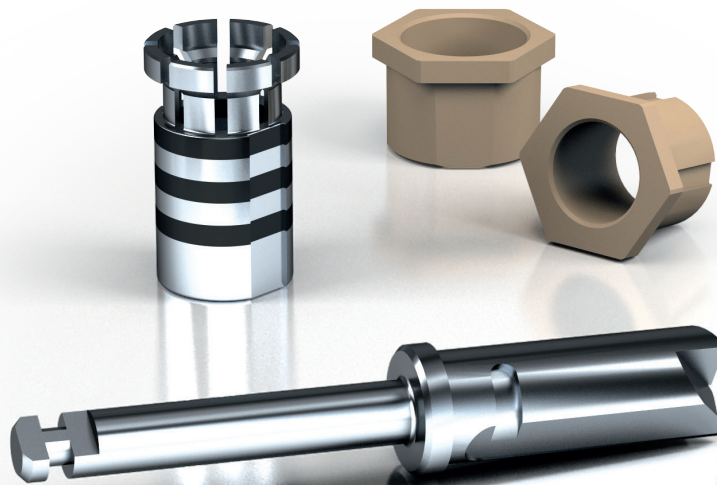

### LIMITED CUTTING THICKNESS

The cutting surface allows for the levelling of a limited bone thickness.

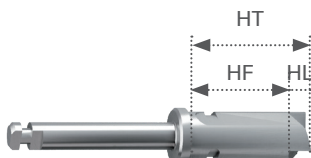

HF Fix height	HL Labour height	HT Total height	CODE
9	2	11	GD-264

RECOMMENDED SPEED: 300 rpm



### 3 LANCE DRILL

The next step consists of a lance drill which has the function of creating a hole in the cortical tissue with a depth of 6.00 mm that permits a guide and the greater stability of successive drills. The lance drill can be used separately or combined with a converter (A) to fit the 5.5 mm diameter sleeve.

#### ONE FOR ALL DIAMETERS

It can also be used in 5.5 mm diameter sleeves thanks to the converter.



#### PENETRATING TIP

It has the function of piercing the cortical bone and decreasing the resistance on subsequent drills.

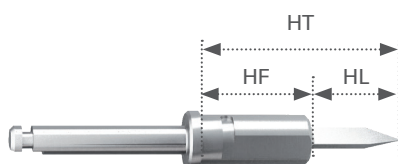

HF Fix height	HL Labour height	HT Total height	CODE
9	7	16	GD-LANCIA

**RECOMMENDED SPEED:** spongy bone 350 - 600 rpm  
hard bone 800 - 1000 rpm

# PREPARATION INSTRUMENTS

## 4 GUIDED DRILLS

The drills for the preparation of slim, 3P and EV lines have the same external geometry and differ in diameters and different conformations of the threads. Given the common cylinder-conical morphology for the preparation of the site, the same drills are used. The preparation drills have a cylindrical-conical shape with a two-edged helical geometry in drills of up to 3.00 mm, while there are 4 straight-tooth blades in upper diameter drills. To facilitate the choice of drills during surgery, all the preparation instruments are equipped with a coloured o-ring that allows you to easily identify the drill depending on the diameter of the chosen implant.



### COLORED O-RINGS

The colour classification allows for an easy identification of the drill suitable for the implant diameter.

### LASER ETCHING

They identify the diameters and lengths of the corresponding implants.

### CONVERTER

For the adaption of drills with diameters of up to 4 mm to 5.5 mm sleeves. Press-fit and easy release.

Add 0.5 mm to the length of the drill, taking into account the sharp angled tip.

### NOTE

Always bring the drills to the full-travel stop making sure to use the cooling systems to avoid excessive overheating. The drills prepare an osteotomy increased by 0.5 mm compared to the length of the implant.

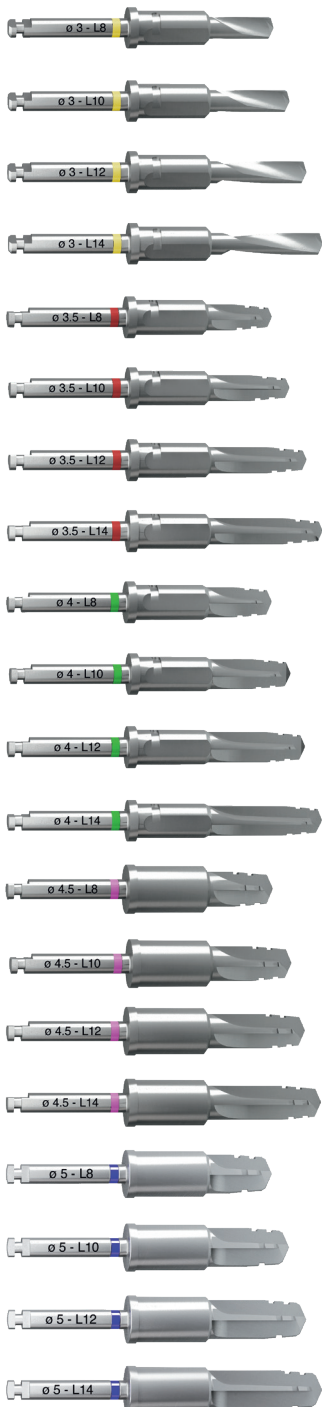
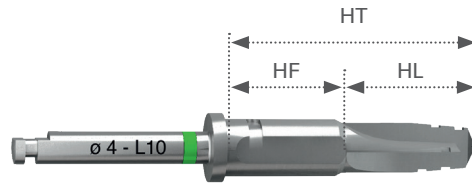

Ø DRILL	HF Fix height	HL Labour height	HT Total height	Ø NECK	CODE
Ø 3	9	8.5	17.5	4.2	GD-30-08
		10.5	19.5		GD-30-10
		12.5	21.5		GD-30-12
		14.5	23.5		GD-30-14
Ø 3.5	9	8.5	17.5	4.2	GD-35-08
		10.5	19.5		GD-35-10
		12.5	21.5		GD-35-12
		14.5	23.5		GD-35-14
Ø 4	9	8.5	17.5	4.2	GD-40-08
		10.5	19.5		GD-40-10
		12.5	21.5		GD-40-12
		14.5	23.5		GD-40-14
Ø 4.5	9	8.5	17.5	5.5	GD-45-08
		10.5	19.5		GD-45-10
		12.5	21.5		GD-45-12
		14.5	23.5		GD-45-14
Ø 5	9	8.5	17.5	5.5	GD-50-08
		10.5	19.5		GD-50-10
		12.5	21.5		GD-50-12
		14.5	23.5		GD-50-14

RECOMMENDED SPEED: spongy bone 350 - 600 rpm  
hard bone 800 - 1000 rpm

## 5 COUNTERSINK DRILLS

Countersink drills are used to shape the cortical bone where there is highly compact bone.

### COLORED O-RINGS

The colour classification allows for an easy identification of the drill suitable for the implant diameter.



### LASER ETCHING

They identify the diameters and lengths of the corresponding implants

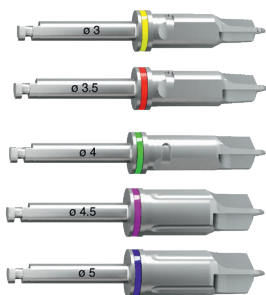
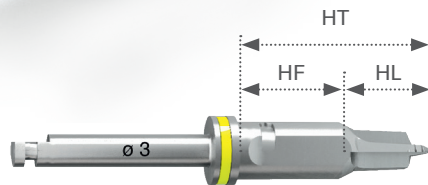

Ø DRILL	HF Fix height	HL Labour height	HT Total height	CODE
Ø 3	9	6	15	GD-SV-30
Ø 3.5				GD-SV-35
Ø 4				GD-SV-40
Ø 4.5				GD-SV-45
Ø 5				GD-SV-50

RECOMMENDED SPEED: spongy bone 350 - 600 rpm  
hard bone 800 - 1000 rpm

## 6 COMPACTORS

In the case where, on the contrary, the bone is not very dense, compactors can be used to achieve better conditions to obtain greater primary stability. The rounded tip of these instruments makes them suitable even in cases of osteotomies in areas surrounding the sinus.



### COLORED O-RINGS

The colour classification allows for an easy identification of the drill suitable for the implant diameter.

### LASER ETCHING

They identify the diameters and lengths of the corresponding implants.

### NOTE

The compactors should not be screwed to the end, the laser markings identify the length of the preparation.

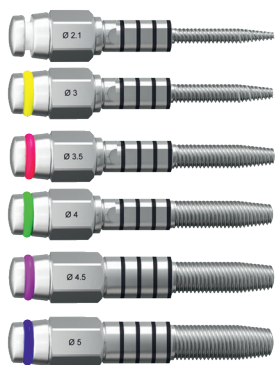
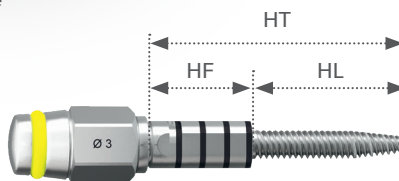

Ø COMPACTORS	HF Fix height	HL Labour height	HT Total height	CODE
Ø 2.1	9	14.3	23.3	GD-761/2
Ø 3				GD-761/2A
Ø 3.5				GD-761/3A
Ø 4				GD-761/4A
Ø 4.5				GD-761/5A
Ø 5				GD-761/6A

RECOMMENDED SPEED: manual insertion with moderate speed

# MOUNTERS AND DRIVERS

## E MOUNTERS AND P MOUNTER EXTRACTOR

The mounters have the function of guiding the final insertion of the implant in terms of angulation, height and orientation. This component has a repeating hexagon with faces that are aligned with those of the implant connections that guides the operator during insertion. The faces of the hexagon must be made to match the direction of the sleeve inside the guide. The mouter extractor (P) helps the insertion of the mounters from the surgical templates by levering them in the dedicated lateral lodge on the mounters.



### COLOR CODED

To help choosing the right height and diameter.

### LATERAL LODGE

For an easy extraction from the surgical template.



Ø IMPLANT	HEIGHT	CODE
Ø 3	0	GD-768/3
	+2	GD-768/32
	+4	GD-768/34
Ø 3.5 - 4	0	GD-768/1
	+2	GD-768/12
	+4	GD-768/14
Ø 4.5 - 5	0	GD-768/2
	+2	GD-768/22
	+4	GD-768/24

**RECOMMENDED TORQUE:**  
50 N/cm

## F DRIVER FOR MOUNTERS

There is a driver for mounters inside the surgical kit used to transport the mounters and implants inside the mouth and screw the implant. The mounter is provided with an internal screw that must be screwed onto the implant; the driver will then be anchored to the mounter before extracting the implant from the blister pack. Once the implant has been inserted and the internal screw of the mounter unscrewed, it should be helpful to use the extractor (P) mounted on the straight manual key (L) to remove the mounters from the sleeves using it as a lever in the dedicated lateral lodges.

## G DIRECT DRIVER

This driver allows the implant to be transported via a spring-loaded attachment mechanism. It is available in two diameters (for SLIM implants marked with a yellow o-ring and for 3P and EV line implants); they can be used separately with 4.2 mm diameter sleeves, but also in combination with the converter (A) for implant sites with 5.5 mm diameter sleeves.

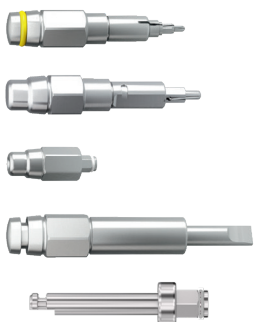
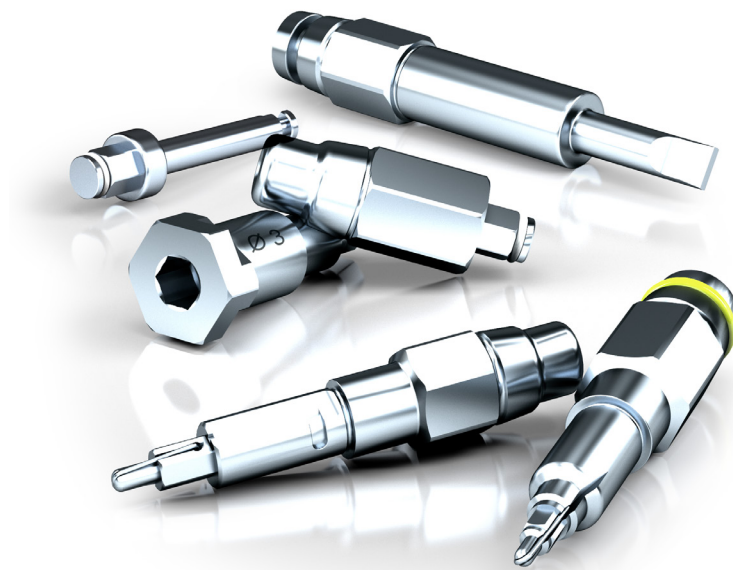

Ø IMPLANT	HEIGHT	CODE
Ø 3	17	GD-00578
Ø 3.5 - 4 - 4.5 - 5	15	GD-701
Ø 3.5 - 4 - 4.5 - 5	-	GD-769
-	-	GD-776
-	19.5	GD-00778

MAXIMUM TORQUE ALLOWED:  
50 N/cm

# KEYS, RATCHETS & EXTRACTOR

## H SCREW DRIVERS

There are two screw drivers in the kit, one short and one long which can be used either manually or coupled to the torque ratchet, necessary for screwing and unscrewing the mounter screws, locking screws, transgingival screws and abutment fixing screws.

### EXTRACTOR KEY

To retrieve the abutments from the implants

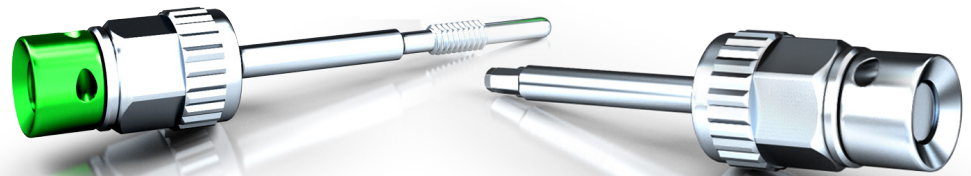

### PROSTHETIC SCREWDRIVERS



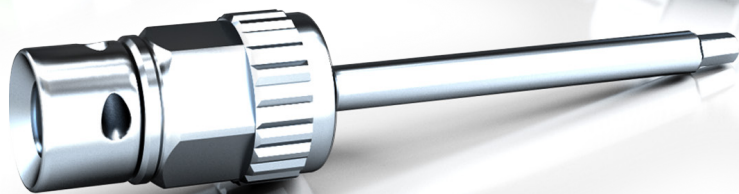

Two measurements to reach all sites

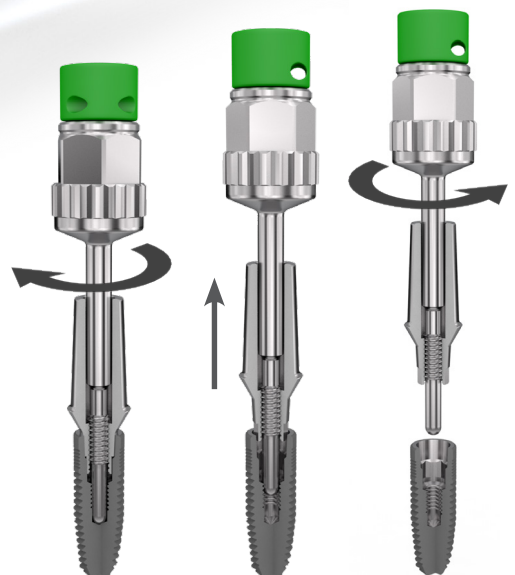

## Q EXTRACTOR KEY

When two conical surfaces connect with each other, a 'morse' or clamping effect is created and the two parts (implant and abutment) lock together. This effect can be canceled by inserting an extraction screw.



	HEIGHT	CODE
	23	INN-61000
	29.5	INN-61000L
	32	INN-6161*
	36	INN-6161L

\* NOT inside the kit



## I RATCHETS AND L STRAIGHT MANUAL KEY

The kit is provided with two ratchets, a dynamometric one and a fixed one, to allow you to work by controlling both the screwing force (up to 50 N/cm) as well as applying greater force. The screwing limits beyond which risk breakage are 25 N/cm per the prosthetic 3P and EV screws, 20 N/cm for the screws of the SLIM implants, and 15 N/cm for the MUA and flat abutment screws. The ratchets can be used in function IN (screw) or OUT (unscrew) by changing the side of use. The key is used to manually insert the implant allowing for the direct application of force. Thanks to the secure grip, it provides a firm hold.



### ADJUSTABLE TORQUE

By turning the end, the tightening torque can be adjusted from 0-50 with the possibility of transforming it into a fixed ratchet ( $\infty$ ).

**Warning:** torque adjustment on a torque ratchet is done by means of a ferrule placed on the handle of the instrument.



HEIGHT	CODE
90	00376DIN
90	00376
50	3P-00090CM

# COMPONENTS FOR MUA

## M REAMER

## N O POSITIONERS

The reamer, used once the implant is installed, has the function of modelling the cortical bone structure around the implant platform. The positioners allow for an easy positioning of the multi-unit abutments (MUA).

The positioner for the straight MUA hooks onto the component vertically, while the one for the angled MUA is screwed into the insertion hole of the fixing screw, leaving the hole free for the implant attachment screw.

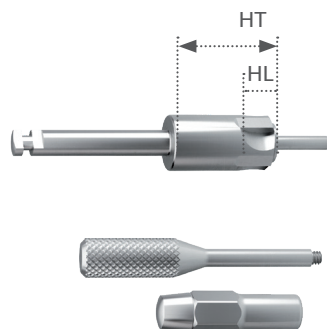
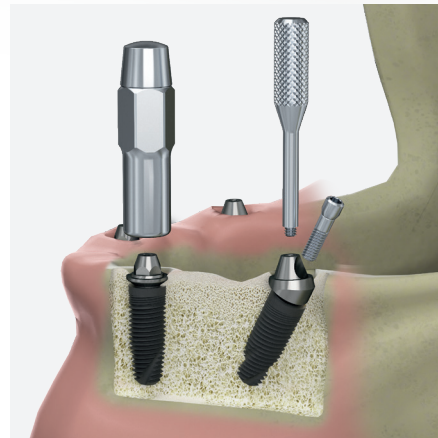
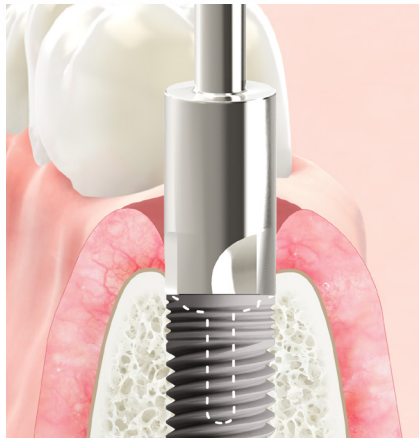
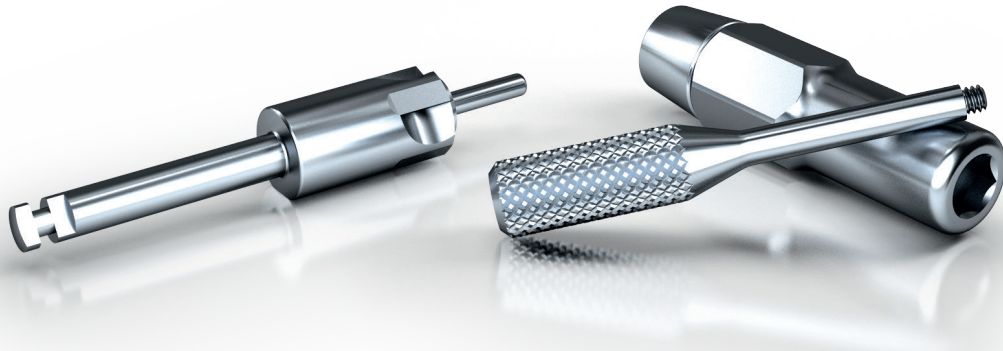

HL Labour height	HT Total height	CODE
3.5	15	GD-BM

HL	CODE
25	023-MUA
23	INN-00637

# IMPORTANT MEASUREMENTS

In order to determine the final position of the implant, and choose the appropriate length of drills, mounters and accessories, it is necessary to keep in mind the following dimensions: B & B Dental implants should be positioned 1 mm under the crest to permit the platform switching effect that makes for an effective result when combined with the cone morse connection that characterizes our implants.

There are 3 series of mounters (0, +2 and +4): the height 0 mounters are those normally used when the external opening of the sleeve is positioned 9 mm above the level of the implant platform; the other heights, +2 and +4, are useful in cases where the mucosa is thicker in order to avoid the opening of a flap or gengivoplasty, therefore requiring a decision to raise the level of the sleeve during the planning stage. In this second case, it is necessary to use the drills and the preparing instruments for the osteotomy with an enhanced length according to the position +2 and +4 of the sleeve. For example, 10 mm implant length with a sleeve in a +2 position, the final drill will be 12 mm length.

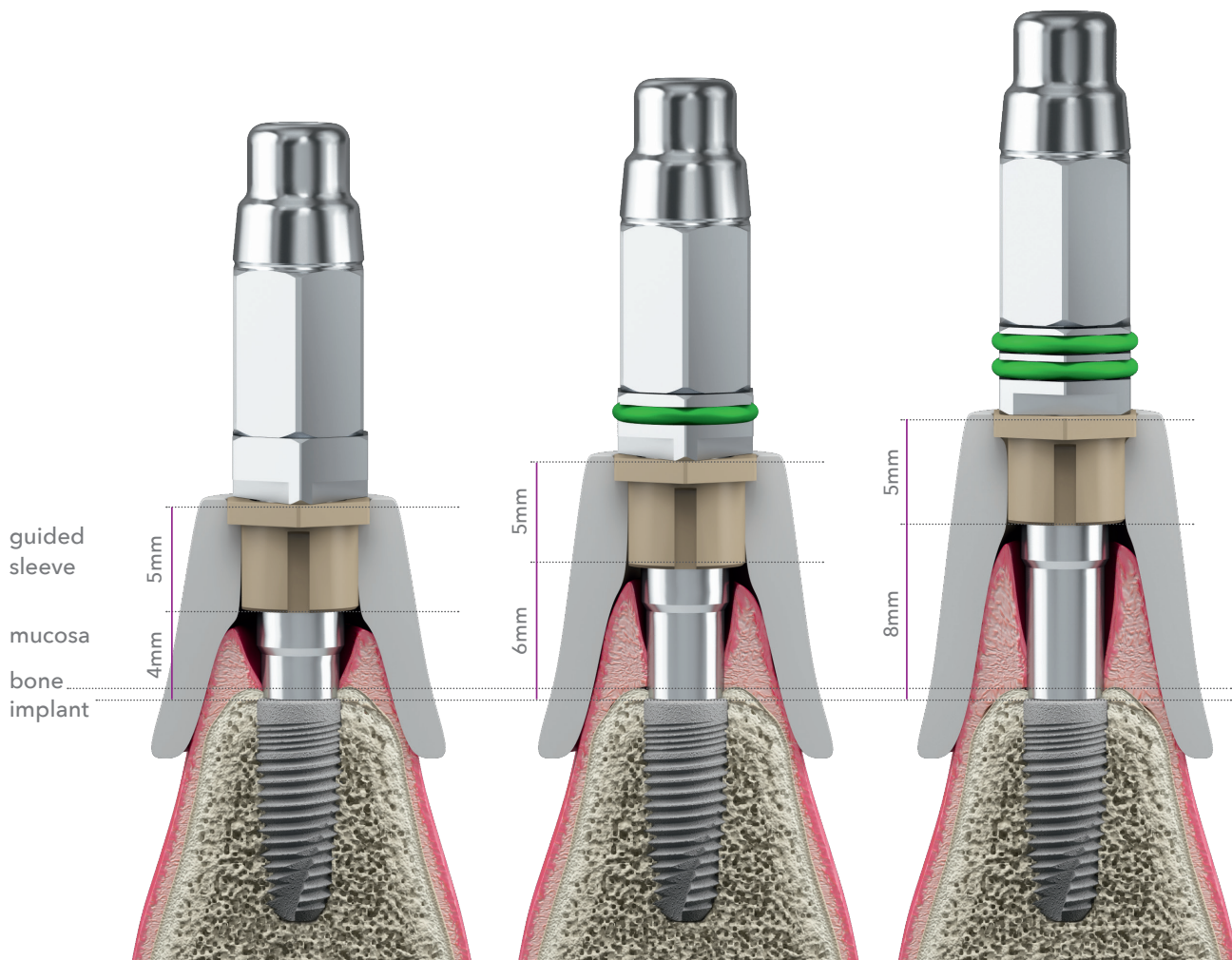

NB: with the sleeve in position +2, you can insert implants up until the maximum length of 12 mm.

NB: with the sleeve in position +4, you can insert implants up until the maximum length of 10 mm.

# PROTOCOL



## 4.2 MM Ø SLEEVE

The drills are to be used successively in order to prepare the implant site to a size suitable for the implant to be placed in position. It is important to assess the hardness of the bone as hard bone may need the use of countersink drill to decrease the resistance given by the cortical bone. In cases where the bone is spongy, the use of compactors may be necessary to obtain primary stability.

### HARD BONE PROTOCOL

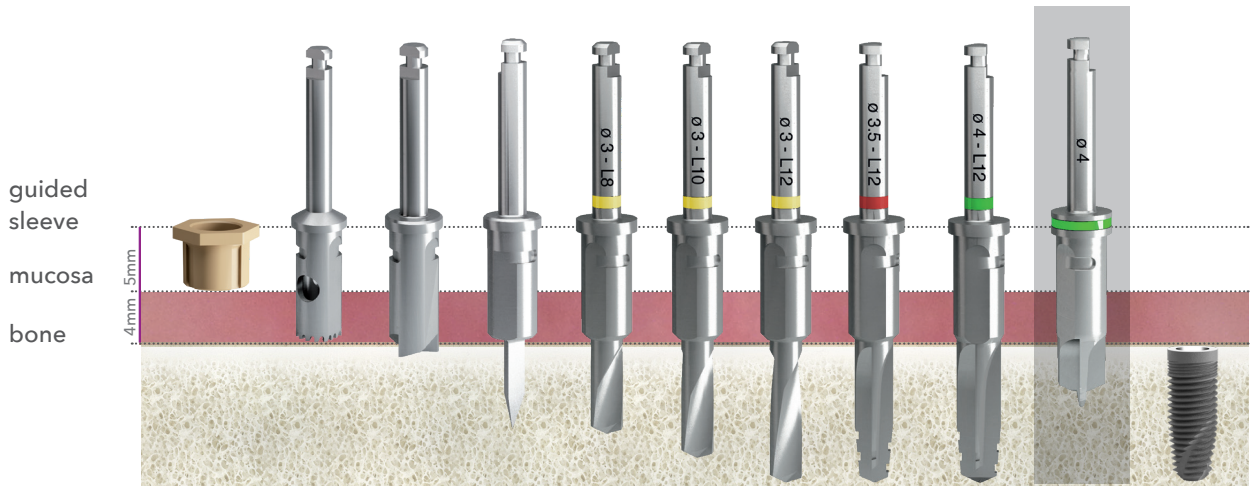

RECOMMENDED SPEED: spongy bone 350 - 600 rpm  
hard bone 800 - 1000 rpm

### SPONGY BONE PROTOCOL

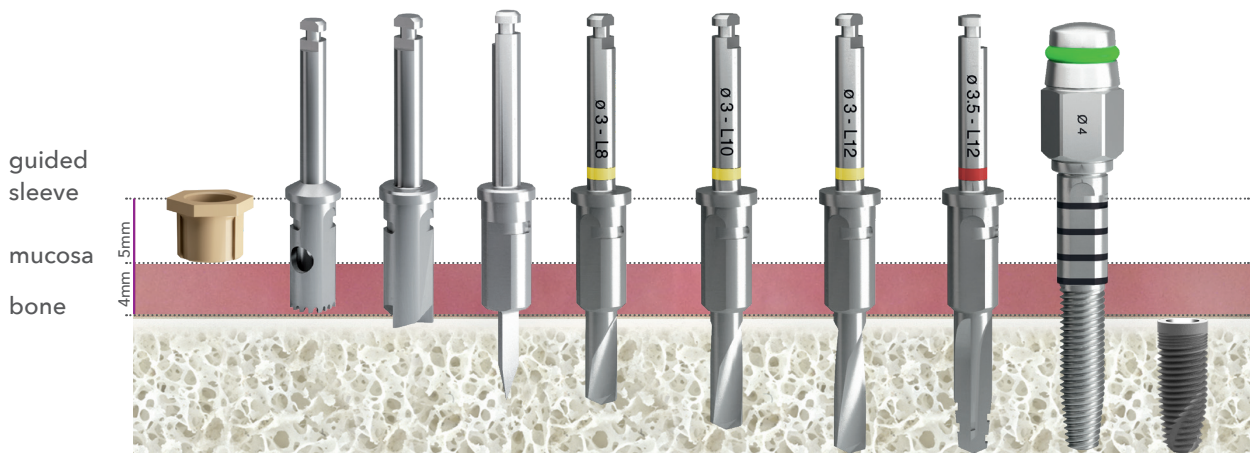

### NOTE

Always bring the drills to the full-travel stop making sure to use the cooling systems to avoid excessive overheating. The drills prepare an osteotomy increased by 0.5 mm compared to the length of the implant.



**5.5 MM Ø SLEEVE**

The first drills for the preparation of the osteotomy with 5.5 mm sleeves diameter must be coupled to the converter, allowing for a guided insertion into the sleeve. Larger diameter drills are already prepared with a neck diameter suitable for the wide sleeve.

**HARD BONE PROTOCOL**

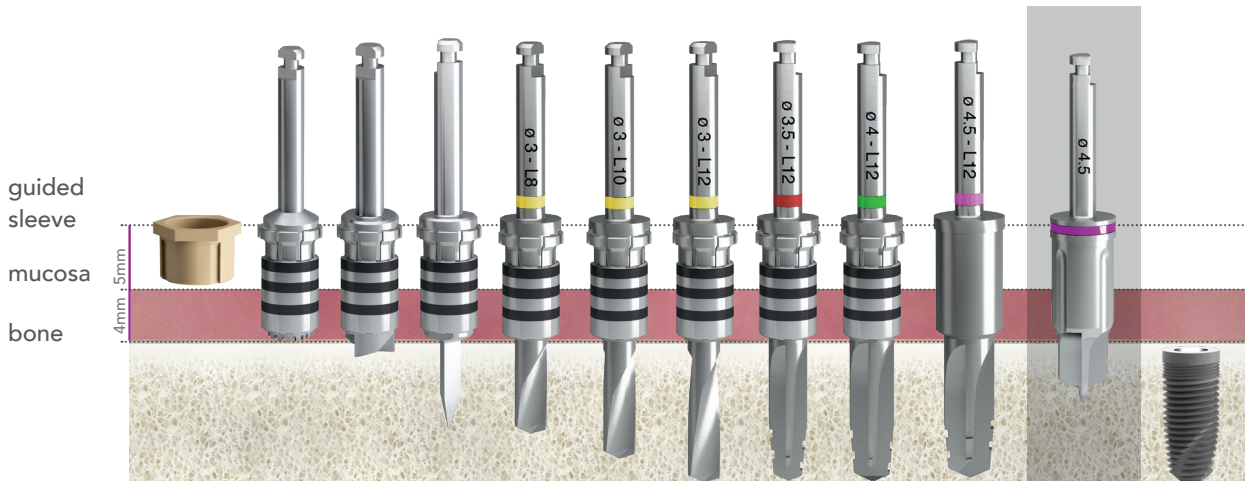

**SPONGY BONE PROTOCOL**

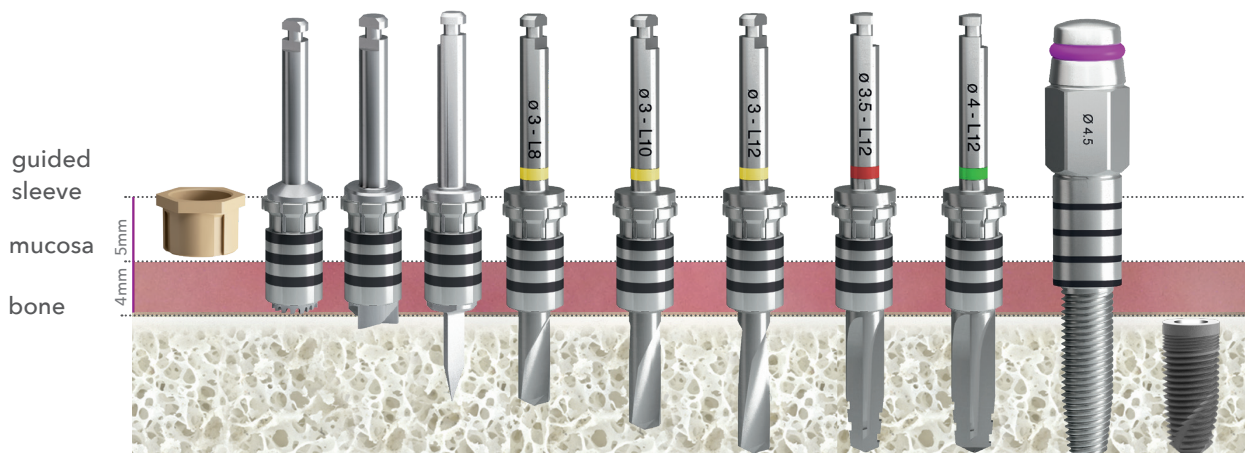

## EV-3P LINE

IMPLANT	UPPER DIAMETER (mm)	SLEEVE	ANALOGUE	MUCOTOME	CRESTAL LEVELLER	LANCE DRILL
3P-3508	3,50	GD-764P	3D-00585	GD-263	GD-264	GD-LANCIA
3P-3510						
3P-3512						
3P-3514						
3P-4006	4,00	GD-764P	3D-00585	GD-263	GD-264	GD-LANCIA
3P-4008						
3P-4010						
3P-4012						
3P-4014						
3P-4508	4,50	GD-765P*	3D-00585*	GD-263*	GD-264*	GD-LANCIA*
3P-4510						
3P-4512						
3P-4514						
3P-5006	5,00	GD-765P*	3D-00585*	GD-263*	GD-264*	GD-LANCIA*
3P-5008						
3P-5010						
3P-5012						
3P-5014						
EV-4008	4,00	GD-764P	3D-00585	GD-263	GD-264	GD-LANCIA
EV-4010						
EV-4012						
EV-4014						
EV-4506	4,50	GD-765P*	3D-00585*	GD-263*	GD-264*	GD-LANCIA*
EV-4508						
EV-4510						
EV-4512						
EV-4514						
EV-5006	5,00	GD-765P*	3D-00585*	GD-263*	GD-264*	GD-LANCIA*
EV-5008						
EV-5010						
EV-5012						
EV-5014						

## SLIM LINE

IMPLANT	UPPER DIAMETER (mm)	LOWER DIAMETER (mm)	SLEEVE	ANALOGUE	MUCOTOME	CRESTAL LEVELLER
SL-3408	3,40	3,00	GD-764P	3D-0097AN/1	GD-263	GD-264
SL-3410						
SL-3412						
SL-3414						
3P-3008	3,00	2,40	GD-764P	3D-0097AN/1	GD-263	GD-264
3P-3010						
3P-3012						
3P-3014						

## NOTE

Always bring the drills to the full-travel stop making sure to use the cooling systems to avoid excessive overheating. The drills prepare an osteotomy increased by 0.5 mm compared to the length of the implant.

DRILL 1	DRILL 2	DRILL 3	DRILL 4	DRILL 5	DRILL 6	DRILL 7	DRILL 8	CUTTING EDGE Length (MM) -LAST DRILL-
GD-30-08	GD-35-08							8,00
	GD-30-10	GD-35-10						10,00
	GD-30-10	GD-30-12	GD-35-12					12,00
	GD-30-10	GD-30-12	GD-30-14	GD-35-14				14,00
GD-30-08	GD-35-08	GD-40-08						8,00
	GD-35-08	GD-40-08						8,00
	GD-30-10	GD-35-10	GD-40-10					10,00
	GD-30-10	GD-30-12	GD-35-12	GD-40-12				12,00
	GD-30-10	GD-30-12	GD-30-14	GD-35-14	GD-40-14			14,00
GD-30-08*	GD-35-08*	GD-40-08*	GD-45-08					8,00
	GD-30-10*	GD-35-10*	GD-40-10*	GD-45-10				10,00
	GD-30-10*	GD-30-12*	GD-35-12*	GD-40-12*	GD-45-12			12,00
	GD-30-10*	GD-30-12*	GD-30-14*	GD-35-14*	GD-40-14*	GD-45-14		14,00
GD-30-08*	GD-35-08*	GD-40-08*	GD-45-08	GD-50-08				8,00
	GD-35-08*	GD-40-08*	GD-45-08	GD-50-08				8,00
	GD-30-10*	GD-35-10*	GD-40-10*	GD-45-10	GD-50-10			10,00
	GD-30-10*	GD-30-12*	GD-35-12*	GD-40-12*	GD-45-12	GD-50-12		12,00
	GD-30-10*	GD-30-12*	GD-30-14*	GD-35-14*	GD-40-12*	GD-45-12	GD-50-14	14,00
GD-30-08	GD-35-08	GD-35-08	GD-40-08					8,00
	GD-30-08	GD-30-10	GD-35-10	GD-40-10				10,00
	GD-30-08	GD-30-10	GD-30-12	GD-35-12	GD-40-12			12,00
	GD-30-08*	GD-30-10	GD-30-12	GD-30-14	GD-35-14	GD-40-14		14,00
GD-30-08*	GD-35-08*	GD-40-08*	GD-45-08					8,00
	GD-35-08*	GD-40-08*	GD-45-08					8,00
	GD-30-10*	GD-35-10*	GD-40-10*	GD-45-10				10,00
	GD-30-10*	GD-30-12*	GD-35-12*	GD-40-12*	GD-45-12			12,00
	GD-30-10*	GD-30-12*	GD-30-14*	GD-35-14*	GD-40-14*	GD-45-14		14,00
GD-30-08*	GD-35-08*	GD-40-08*	GD-45-08	GD-50-08				8,00
	GD-35-08*	GD-40-08*	GD-45-08	GD-50-08				8,00
	GD-30-10*	GD-35-10*	GD-40-10*	GD-45-10	GD-50-10			10,00
	GD-30-10*	GD-30-12*	GD-35-12*	GD-40-12*	GD-45-12	GD-50-12		12,00
	GD-30-10*	GD-30-12*	GD-30-14*	GD-35-14*	GD-40-12*	GD-45-12	GD-50-14	14,00

LANCIE DRILL	DRILL 1	DRILL 2	DRILL 3	DRILL 4	CUTTING EDGE Length (MM) -LAST DRILL-
GD-LANCIA	GD-30-08				8,00
		GD-30-10			10,00
		GD-30-10	GD-30-12		12,00
		GD-30-10	GD-30-12	GD-30-14	14,00
GD-LANCIA	GD-30-08				8,00
		GD-30-10			10,00
		GD-30-10	GD-30-12		12,00
		GD-30-10	GD-30-12	GD-30-14	14,00



\* add converter cod. GD-708

# PACKAGING

The new packaging is safer and more practical thanks to the anti-tampering opening. Implant holder vial keeps the implant in position, ready to be picked up using ratchet or contraangle spanners. Within each implant packaging is a healing screw and a cover cap.



## SEALED PACKAGING

When packaging is sealed, the symbol is a closed lock of a neutral colour.



## OPEN PACKAGING

After opening, the tab becomes red, with an open lock



## COMPONENTS INSIDE THE PACKAGING:







1 Open the external vial by pulling the tab on the side of the cap.



2 Remove the internal ampoule.



3 Remove the cap of the second vial.

INDIRECT PHASE



4a Engage the fitter (E) (selected according to the type of implant and the diameter of the sleeve) on the implant placed inside the ampoule and screw the implant connection screw with the hexagonal key.



5a 5a Insert the mouter driver (F) inside the mount connection.



6a Prelevare l'impianto ed inserirlo nell'osteotomia.

DIRECT PHASE



4b Insert the direct driver (G) (selected according to the type of implant - insert the converter in cases where there is a larger diameter sleeve) inside the implant connection paying attention that it fits perfectly.



# GUIDE YOUR SURGERY TO PERFECTION

The guided surgery service is built around your skills and needs and includes a set of tools and technical supports that adapt to you, improving your way of working and helping you to implement the digital workflow in your practice.



A software that can be downloaded from B&B Dental website and that is clear, user-friendly, suitable for any device that allows you to view CBCTs, convert DICOM files to STL, plan your cases, leaving you the freedom to work independently but facilitating sharing information with our technicians before finalising.

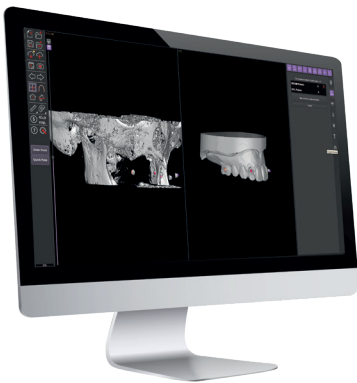

matching

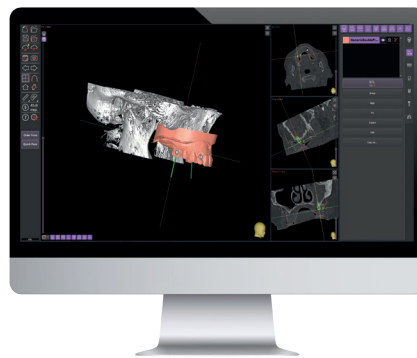

positioning and  
planning of the  
implants



templates finalization

Once the implant project for the insertion of the implants has been completed, it is possible to prepare the prosthetic structure for immediate or deferred loading.

# STRUCTURED TO LAST

The milling center was established as a reference point for the processing and creation of the structures based on your projects, whether for immediate loading after a guided surgery or in general to create the prostheses for your patients.

If you are already an experienced user we can provide you with the libraries to work in a total independent way or you can provide us with the STL files for milling purposes.

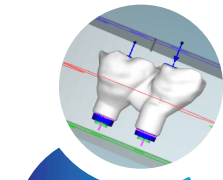

We guide you till the end because thanks to the equipment at our center we can prepare the structures according to the purposes and materials you want.



Our team is here for you, to help you design your prosthetic structures whether you want to finalise them with us, in collaboration with your laboratory, or directly with your trusted laboratory.

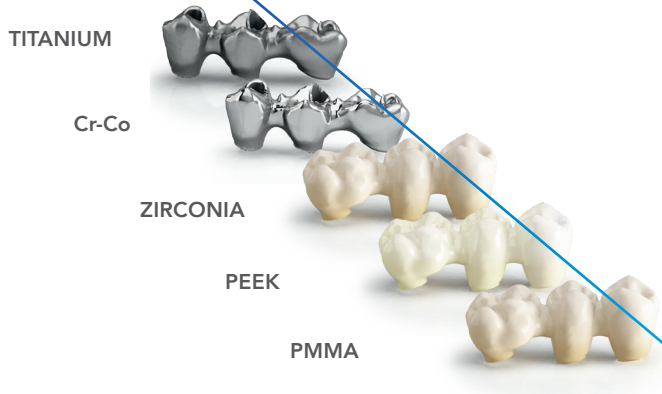

---

# CONTACTS

## REGISTERED OFFICE:

Via S. Benedetto, 1837  
40018 S. Pietro in Casale (BO) Italy

## OPERATIONAL HEADQUARTERS:

Via Due Ponti, 19  
40050 Argelato (BO) Italy

**Tel.** +39 (0) 51.81.13.75

**Fax** +39 (0) 51.666.94.00

[info@bebdental.it](mailto:info@bebdental.it)

[www.bebdental.it](http://www.bebdental.it)



Certified quality system  
UNI EN ISO 13485

